

“The DockSider” Mounting Options

**DockCraft Industries Bolt On Mount for “The DockSider”
- Kayak Dock Rack and Paddleboard Dock Lift -**

Kayak / Paddle Board Dock Rack
Bolt on Mount

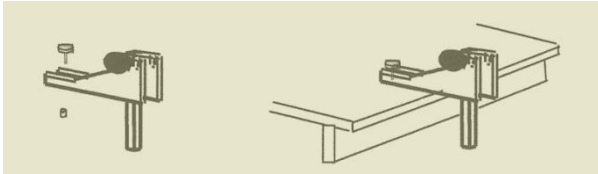

- Bolts in 2 locations per Mount
- 2 Mounts per Dock Rack

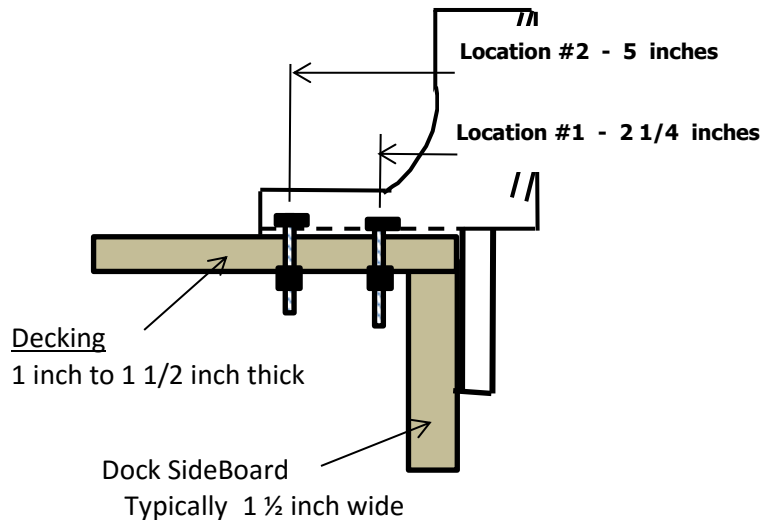

Dock Configuration Guide

Wood Dock with Decking on top of Side Board

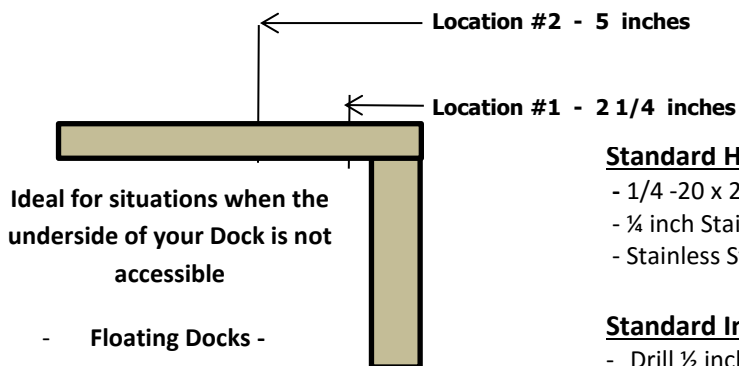

Standard Hardware – Included in Purchase

- 1/4 -20 x 2 1/2 inch Stainless Steel cap screw, each location
- 1/4 inch Stainless Steel washer, each location
- Stainless Steel Snap Toggler, each location

Standard Installation Requirements

- Drill 1/2 inch diameter holes in locations shown
- Insert Snap Toggles per directions from top of Dock
- Insert screws and washers then secure.

Wood Decking overhanging Dock Sideboard

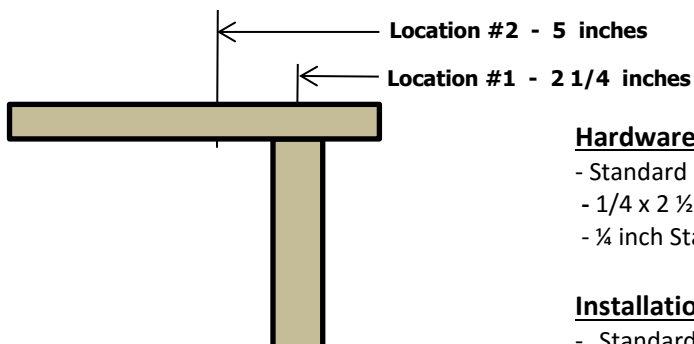

Hardware

- Standard Hardware
- 1/4 x 2 1/2 inch Stainless Steel lag Screw – location #1, not included
- 1/4 inch Stainless Steel washer, each location

Installation Requirements

- Standard Installation; except
- Location #1, Drill 1/8 or 3/16 inch pilot hole through decking and into side board.
- Insert Lag Screw and washers to secure.

Wood Dock with Decking Flush with Side Board

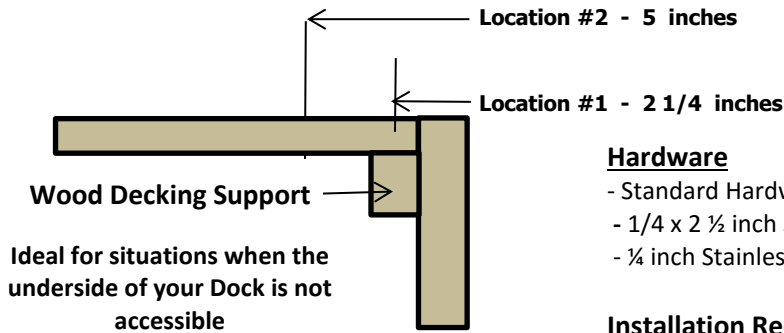

Ideal for situations when the underside of your Dock is not accessible

- Floating Docks -

Hardware

- Standard Hardware
- 1/4 x 2 1/2 inch Stainless Steel lag Screw – location #1, not included
- 1/4 inch Stainless Steel washer, each location

Installation Requirements

- Standard Installation; except
- Location #1, Drill 1/8 or 3/16 inch pilot hole through decking and into the wood decking support.
- Insert Lag Screw and washers to secure.

Wood Decking Flush with Aluminum Side Channel

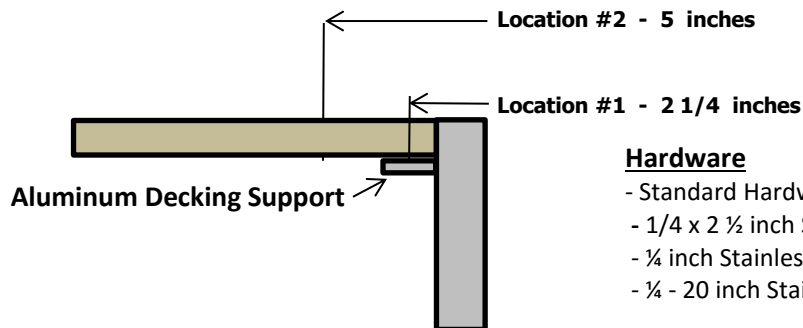

Hardware

- Standard Hardware
- 1/4 x 2 1/2 inch Stainless Steel Cap Screw – location #1, included
- 1/4 inch Stainless Steel washer, each location, included
- 1/4 - 20 inch Stainless Steel nut and lock washer, not included

Installation Requirements

- Standard Installation; except
- Location #1, Drill 3/8 inch hole through decking and aluminum decking support.
- Insert Cap Screw, washer, and lock washer and nut to secure.

Wood Decking – Pipe Dock

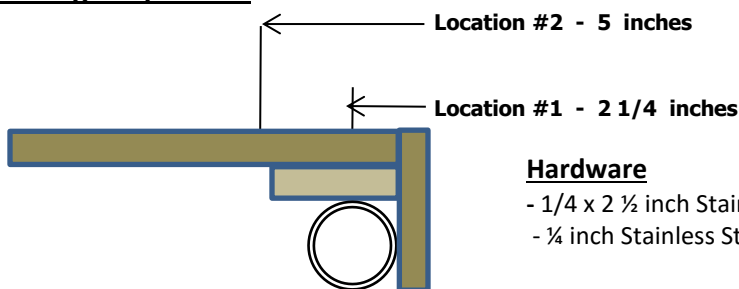

Hardware

- 1/4 x 2 1/2 inch Stainless Steel lag Screw – location #1 & 2, not included
- 1/4 inch Stainless Steel washer, each location

Installation Requirements

- Location #1 & 2, Drill 1/8 or 3/16 inch pilot hole through decking and into the wood decking support.
- Insert Lag Screws and washers to secure.

Aluminum / Vinyl Decking

We do not recommend attaching the Bolt On Kayak / Paddle board Surface Mount **directly** to Aluminum / Vinyl decking as the Decking material is thin, however supported by 3 vertical members.

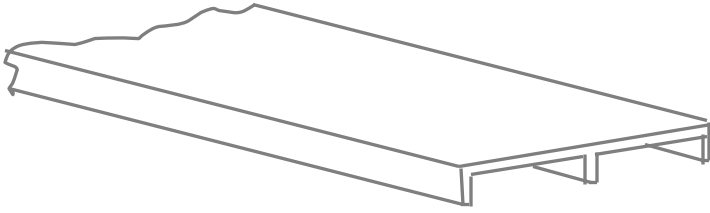

Given you choose to mount the Surface (Bolt On) Mount to Aluminum or Vinyl Decking; it is highly recommended that you install a backer board in the area of the mounting positions.

Option #1

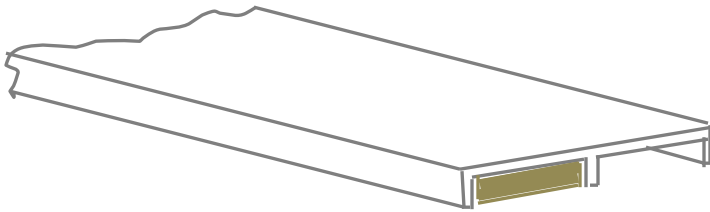

The backer board should be slightly smaller than width between vertical members of decking and at least 6 inches long. The thickness should not extend beyond the height of the decking vertical members.

Option #2

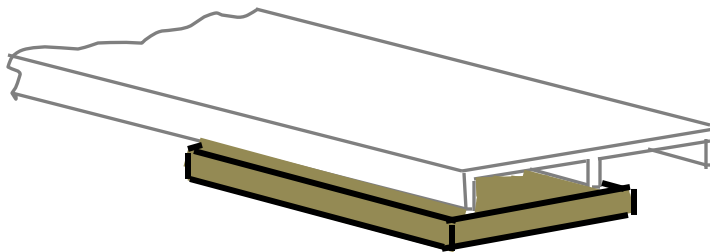

The Backer board should be wider than the width between vertical members of the decking, at least 6 inches long; and have a thickness of $\frac{3}{4}$ to 1 inch.

When securing the Dock Bolt On Mount; the decking is actually clamped between the Bolt On Mount and the Backer Board. Use caution as not to over tighten.